

Are your **MRI contrast agents** cost-effective?

Learn more about generic **Gadolinium-Based Contrast Agents**.



FRESENIUS
KABI

caring for life

AJNR

Short versus long echo time for cranial MR angiography in children and adults.

A S Smith, E M Haacke, W Lin, B Berman and M Wiznitzer

AJNR Am J Neuroradiol 1994, 15 (8) 1557-1564

<http://www.ajnr.org/content/15/8/1557>

This information is current as
of April 19, 2024.

Short versus Long Echo Time for Cranial MR Angiography in Children and Adults

Alison S. Smith, E. Mark Haacke, Weili Lin, Brian Berman, and Max Wiznitzer

PURPOSE: To evaluate the ability of short-echo-time (TE) versus long-TE three-dimensional time-of-flight MR angiography sequences to decrease phase-related signal loss and refocus signal from blood in intracranial MR angiography of adults and children. **METHODS:** We evaluated 3-D time-of-flight cranial MR angiography in 33 cases (18 children and 15 adults) using two sequences. The longer-echo reference sequence had a TE of 8.0 milliseconds and a field echo of 6.5 milliseconds; the shorter-echo sequence had a TE of 5.1 and a field echo of 4.2 milliseconds. Repetition time, flip angle, and matrix were constant. The bandwidth for the longer-echo sequence was 130 Hz, 195 Hz for the shorter-echo sequence. **RESULTS:** The greatest improvement in diagnostic images was for children; significant and mildly improved signal recovery was demonstrated in 15 and 2 cases, respectively, of a total of 18 studies. This allowed improved diagnostic assessment. However, in the adult group significantly and mildly improved signal recovery were present in only 2 and 6 cases, respectively, of a total of 15 studies. In the group of children and adults combined, decreased lumen definition and peripheral vessel visibility were present in 24 and 30 of 33 cases, respectively, because of higher signal from background tissue when the shorter-TE field-echo sequence was used and, hence, reduced vascular contrast. **CONCLUSION:** The use of a short-field-echo/TE sequence is therefore recommended as the initial study in children but as a secondary examination in areas of abnormality in adults. This study illustrates the improved signal recovery from phase-related sources and improved visibility of intracranial stenosis in children with the use of a short-echo sequence. In adults, the short-echo sequence should not be used for the initial screening but reserved for secondary evaluation.

Index terms: Magnetic resonance angiography; Magnetic resonance, comparative studies; Magnetic resonance, in infants and children

AJNR Am J Neuroradiol 15:1557-1564, Sep 1994

Ideally, magnetic resonance (MR) angiography should result in image quality comparable to catheter angiography. One detraction from that goal is signal loss in areas of rapid or disrupted laminar flow. It has been the goal of recent work in MR angiography sequence development to retain all available signal intensity in blood by compensating for constant, velocity, acceleration, and jerk (1-4). Although multiple

scenarios have evolved to reduce higher-order signal loss, first-order (velocity) compensation has been the most dramatic step (5-10). The use of a short gradient-echo structure is, theoretically, an additional improvement, because it decreases the time available for an isochromat of proton spins to experience phase dispersion caused by acceleration and other higher-order terms. Although phantom work using a field echo (FE) as low as 1 millisecond and an echo time (TE) of 3.8 milliseconds has shown improved signal in high-velocity disturbed flow, these measurements required a gradient strength of 37 mT/m and a rise time not clinically available (5). In the clinical setting, we have implemented a TE of 5.1 milliseconds with an FE of 4.2 milliseconds (short-echo sequence), shorter than those in typical use (ie, TE/FE of 8/6.5 milliseconds [long-echo se-

Received June 16, 1993; accepted after revision January 12, 1994.

This work was performed with support from Siemens Medical Systems (Erlangen, Germany).

From the Departments of Radiology (A.S.S., E.M.H., W.L.) and Pediatric Neurology (B.B., M.W.), University Hospitals of Cleveland.

Address reprint request to Alison S. Smith, MD, Aultman Hospital, Department of Radiology, 2600 Sixth St SW, Canton, OH 44710.

AJNR 15:1557-1564, Sep 1994 0195-6108/94/1508-1557

© American Society of Neuroradiology

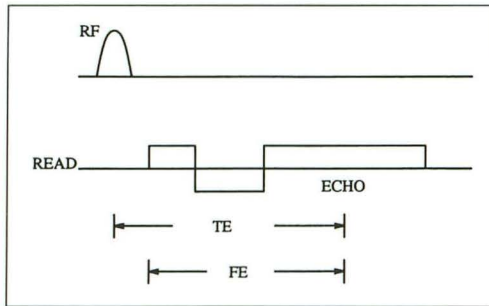

Fig 1. FE is the time between the first lobe of the read gradient to the echo time. The TE is the time between the first radio frequency (RF) pulse and echo.

quence]), in the hope of decreasing higher-order signal loss and improving lumen definition in stenotic or tortuous flow (6–13). However, the improvement in the resultant images seemed extremely variable until divided by the subset of age. This study illustrates the advantage of a short-echo versus a long-echo sequence when using three-dimensional time-of-flight intracranial MR angiography sequences in children compared with adults. We suggest the use of such a short-echo sequence as the initial study in children for intracranial MR angiography.

Materials and Methods

Sequences

Two sequences were used in the comparison study. Both had some degree of asymmetric echo data acquisition. The FE structure of each was first-order velocity compensated along both frequency- and section-encoding directions. (FE refers to the time associated with the turning on of the first lobe of the read gradient to the echo time, whereas TE refers to the time from the first radio frequency pulse to the time of the echo [Fig 1].)

The TR, flip angle, and resolution were constant for the two sequences. TE, FE, and bandwidth varied as described. The first sequence (Fig 2A) has a TE and FE of 5.1 and 4.2 milliseconds, respectively, and an acquisition window of 512 points with 32 points before the echo (6.25% asymmetric). The bandwidth of this sequence is 195 Hz per pixel. The second sequence (Fig 2B) used has an FE of 6.5 milliseconds and a TE of 8 milliseconds. The number of points before the echo were 64 with a 512-point acquisition window (12.5% asymmetric). The bandwidth is 130 Hz per pixel, and the total sampling time is 15.36 milliseconds. The minimum fields of view were 185 and 200 cm for the cases with TEs of 8 and 5.1 milliseconds, respectively. Usually 64 partitions were acquired with a repetition time of 35 milliseconds, a flip angle of 15°, and a 64- to 80-mm-thick slab. Normal 3-D fast Fourier transform was used, but 512 points were acquired along the frequency-encoding direction whenever possible (to avoid loss of small vessels caused by blurring from the asymmetric sampling window and to allow better maximum-intensity projection display). Only 256 phase-encoding

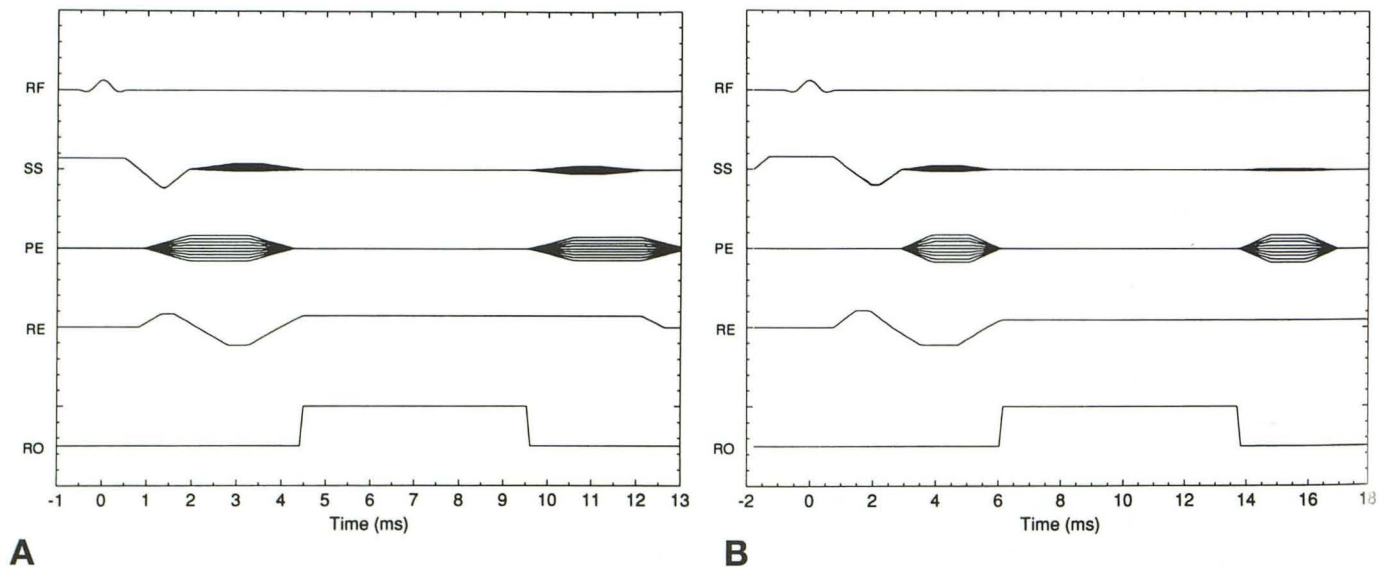

Fig 2. Sequence diagrams for velocity-compensated 3-D MR angiographic scans. The timing is set to zero at the center of the radio frequency (RF) pulse. The section select (SS) gradient is velocity compensated, and a tab file is set for spoiling after the readout (RO) period. The phase-encoding (PE) gradients are rewound after the readout period. The read (RE) gradient is velocity compensated.

A, The TE and FE values are 5.1 and 4.2 milliseconds, respectively, and the number of points before the echo is 32.

B, The TE and FE values are 8.0 and 6.5 milliseconds, respectively, and the number of points before the echo is 64.

steps were acquired, and the data were zero filled and the image reconstructed as a 512×512 image. One study was performed with a 256×256 matrix. Saturation pulses were not used. Magnetization transfer pulses were used with the short-echo sequence in 10 cases (to suppress background signal). The magnetization transfer pulse used has a frequency offset of 2 kHz, a bandwidth of 250 Hz, and a duration time of 8.192 milliseconds. The B1 field of this pulse was kept constant throughout the entire study. All images were acquired on a Siemens 1.5-T Magnetom system (Siemens Medical Systems, Erlangen, Germany) with 10-mT/m gradient and 1-millisecond rise times.

Images were viewed using a maximum intensity projection algorithm.

Patient Studies

Intracranial MR angiograms were performed on 33 patient volunteers. Informed consent was obtained from all adult patients and from parents or guardians of all children. In the pediatric group of 18 patients, ages ranged from 1 month to 20 years (mean, 9.6 years). Four had presented with hemipareses, 3 with hemiplegias, 2 with transient ischemic attacks, 1 with cranial neuropathy, 4 with headaches, 1 with hydrocephalus, and 2 with seizures. One study was an extracorporeal membrane oxygenation (ECMO) follow-up. Ten patients had sickle cell disease. In the adult population, 15 patient volunteers were studied (age range, 29 to 75 years; mean, 46.9 years). Indications for study were 8 strokes, 3 headaches, 1 mass, 1 arteriovenous malformation, 1 seizure, and 1 cranial neuropathy (see Table 2).

Because the short-TE sequence results in relatively higher signal from fat, the study was considered non-blinded. The images were reviewed by two observers (A.S. and M.W.) and categorized by consensus, without significant discrepancies. In regions where phase-related signal loss from acceleration and higher-order terms was expected or present on the longer-echo sequence, the increase in intraluminal signal intensity on the short-echo sequence was assessed. Signal change was judged significant, mild, or none: significant indicated a moderate or marked change that would potentially make a diagnostic difference, and mild indicated a change not thought to make a diagnostic difference. Additionally, definition of luminal margins and conspicuity of small or peripheral vessels were separately assessed using a similar comparison outside the areas of expected phase-related signal loss.

Results

In the pediatric group, 17 of 18 cases showed less phase-induced signal loss with the short-echo sequence (Table 1). Significant signal improvement was seen unilaterally or bilaterally at the internal carotid bifurcation (11 of 18 cases) and internal carotid artery siphon (13 of 18 cases) (Fig 3). There was significant improve-

TABLE 1: Results of short-echo improvement over long-echo intracranial time-of-flight MR angiographic sequences

Age Range	Internal Carotid Artery Siphon	Internal Carotid Artery Bifurcation	Other Vessel	Lumen Definition	Peripheral Vessel Visualization
1 mo-2 y (n = 18)	13 S ↑ 1 M ↑	11 S ↑ 1 M ↑	8 S ↑	6 M ↑ 12 M ↓	1 M ↑ 15 M ↓
29-75 y (n = 15)	1 S ↑ 17 —	1 S ↑ 6 M ↑	2 S ↑ 2 S ↓	16 M ↓ 2 —	2 S ↓ 16 M ↓

Note.—Results are listed as significant (S), mild (M), or no improvement (—) relative to the diagnostic image quality of the short-TE/short-FE technique. Arrows indicate improved (↑) or decreased (↓) quality. Lumen definition and peripheral vessel detail relative to the longer-echo study were similarly assessed.

ment in signal in 3 of 4 cases of middle cerebral artery stenosis or occlusion and no improvement in 1 case (Figs 4 and 5). Significant improvement in signal was present at the middle cerebral artery genu (2 cases), in visibility of PCOMA (4 cases), and in visibility of the posterior cerebral artery (2 cases). There was mild improvement at the carotid siphons and the internal carotid artery bifurcations (1 case). Six of 18 cases showed improved and 12 of 18 showed decreased lumen definition outside areas of expected phase-related signal loss. Peripheral vessel visibility with the short-echo sequence was improved in only 1 case. Of the remainder, 15 of 18 showed decreased peripheral vessel visibility.

In the adult population, significant reduction in phase-related signal loss from acceleration and higher-order terms was present in only 2 of 15 cases (Table 2): the arteriovenous malformation (Fig 6) and a middle cerebral artery genu. Mild signal improvement was seen at the internal carotid artery siphons in 6 of 15 cases. Despite the improvement in signal in some areas of vessel tortuosity, lumen definition in peripheral or small vessels was decreased in 13 of 15 patients, and the peripheral vessel definition decreased in all cases using the short echo, severely in 2 cases (Fig 7). The use of magnetization transfer contrast and matrix size did not affect differences in the images of short versus long echo.

Discussion

The images of this study clearly indicate the improved signal of intracranial three-dimensional time-of-flight MR angiography with the

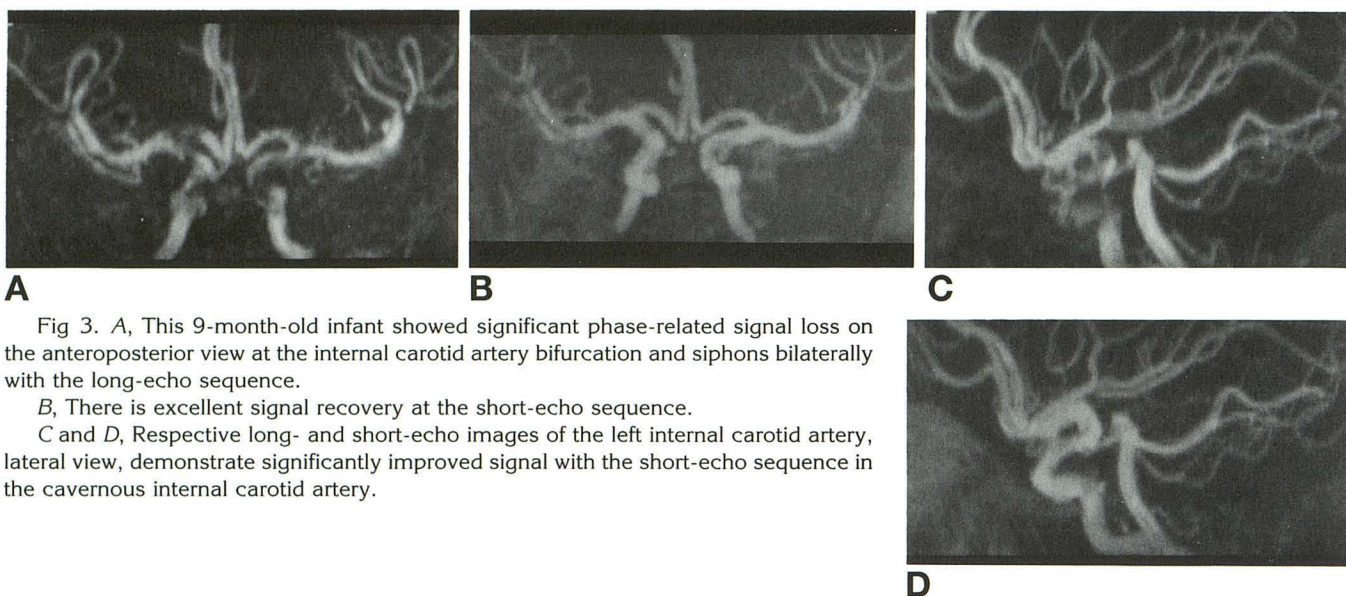

Fig 3. A, This 9-month-old infant showed significant phase-related signal loss on the anteroposterior view at the internal carotid artery bifurcation and siphons bilaterally with the long-echo sequence.

B, There is excellent signal recovery at the short-echo sequence.

C and D, Respective long- and short-echo images of the left internal carotid artery, lateral view, demonstrate significantly improved signal with the short-echo sequence in the cavernous internal carotid artery.

shorter-TE and -FE images for children. In the adult population, the improvement in phase-related signal loss was generally mild, compared with the significant improvements for the children. The short-echo sequence in adults would be more useful as a second exam to define better any areas of possible stenosis noted on the initial, longer-echo exam (Fig 5). Outside the areas where phase-related signal loss was expected, lumen definition and conspicuity of small or peripheral vessels was generally decreased with the short-echo sequence, more notably in adults (Figs 6 and 7).

We have found that phase-related signal loss such as vessel bifurcations, areas of tortuosity, and stenosis presents many problems in children. This is especially true in our pediatric group with sickle cell disease, in whom the

carotid siphon is of particular interest for evaluation of large-vessel stenosis. Phase-related signal loss may be misinterpreted as a false-positive result or overestimation of stenosis, or even may be uninterpretable (Figs 3–5). In three of the four cases of proximal middle cerebral artery stenosis, the degrees and lengths of the stenoses were better seen as proved by the one angiographic correlate case (Fig 4). Indeed, Heiserman et al (14) found better statistical correlation with angiography for intracranial stenosis between groups using 3-D time-of-flight MR angiography at a shortened TE of 4.9 milliseconds than with a TE of 10 milliseconds. In the children, we found significant improvement in vessel signal in locations corresponding to areas of phase-related signal loss using the short-echo sequence than the

Fig 4. Nine-year-old child with acute hemiplegia.

A, The stenosis of the left middle cerebral artery is overestimated on the 0° maximum intensity projection with the longer-echo sequence TE and FE of 8 and 6.5 milliseconds, respectively (arrow).

B, The short-TE/short-FE sequence shows a more discreet stenosis (arrow), which was confirmed at catheter angiography. Also note the loss of peripheral small vessel detail compared with A.

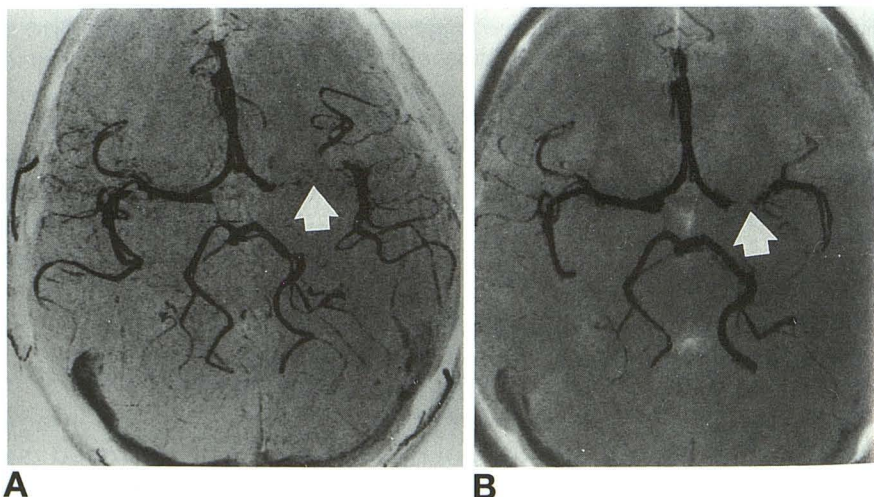

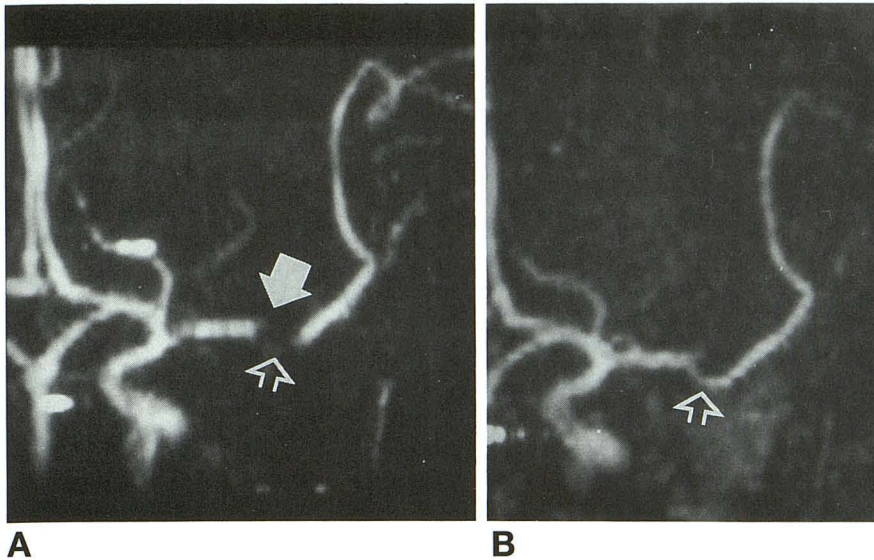

Fig 5. Fourteen-year-old boy with acute hemiplegia.

A, There is a major middle cerebral artery branch occlusion (*arrow*) shown on the anteroposterior view. The longer-echo study suggests a lower-branch stenosis (*open arrow*).

B, The short-echo study shows normal continuity of the lower vessel (*open arrow*).

longer-echo sequences. We surmise that the short-echo sequence yields such a dramatic improvement in image quality in children over adults because of higher intracranial flow in children. Although the short-echo sequence results in less phase-related signal loss, it potentially has lower signal-to-noise and contrast-to-noise ratios outside regions where signal loss is recovered than the longer-echo images, as discussed below. The higher inflow in the pediatric group, which supplies rapid renewal of unsaturated flow, results in higher signal-to-noise and contrast-to-noise ratios that offset the short-echo sequence with a net improvement over the longer-echo series. Intracranial velocities as studied by transcranial Doppler show definite changes with age. Middle cerebral artery velocity is the best studied, although similar trends have been found for the internal carotid artery and other intracranial vessels (15). The middle cerebral artery

velocity is about 24 cm/s after birth, rising rapidly in the first few days. Between ages 3 and 6 years it rises at 10 cm/s per year, reaching a peak velocity of 100 cm/s between ages 4 and 6 years. The velocity then declines through adulthood (Table 2). The adult rate is 40 cm/s in the seventh decade (16). Although intracranial vessel diameters increase with age, the drop in velocities is thought to correlate more with age-related changes in cerebral blood flow (16). Both velocity and cerebral blood flow show inverse linear changes with hematocrit (ie, sickle cell disease) and positive polycythemia. The normal cerebral blood flow in adults is 50 mL/100 mg per minute. In children 0 to 3 years old, this value is 30 to 60 mL/100 mg per minute, increasing to 105 mL/100 mg per minute in children 3 to 10 years old and gradually declining into young adulthood to the adult level. Higher rates in asymptomatic children with sickle cell disease of 80 to 130 mL/100 mg per minute for ages 3 to 16 years have been observed (17). The cerebral blood flow in infants depends on the technique, neurologic status, and gestational age. Data vary from 17 mL/100 g per minute for comatose newborns with respiratory distress to 31 mL/100 g per minute for healthy preterm infants (34 weeks' gestation) to 40 to 63 mL/100 g per minute for healthy newborns (17).

In our study, the only adult cases in which the short-echo sequences showed significant improvement in signal were because of the fast flow in the arteriovenous malformations or at

TABLE 2: Intracranial middle cerebral artery velocity changes with age

Age range, y	cm/s	Change per year, cm/s
Birth	24	
3-6		>10
4-6	100	
6-16		<1-2
17-69		<0.75
70	40	

Note.—Middle cerebral artery velocities based on intracranial ultrasound data show higher inflow rates in children. The rapid renewal of unsaturated flow in children yields higher signal-to-noise and contrast-to-noise ratios for time-of-flight MR angiography.

Fig 6. An arteriovascular fistula in a 32-year-old patient is present in the right temporal lobe.

A, 0° maximum intensity projection from the long echo; B, short-echo sequence. Note better peripheral vessel visualization and lumen definition of the distal posterior cerebral arteries in the long-echo image (A). There is a recovery of signal loss in the short-TE/short-FE image (B) at the internal carotid artery bifurcations, proximal posterior cerebral arteries, and the left middle cerebral artery genu.

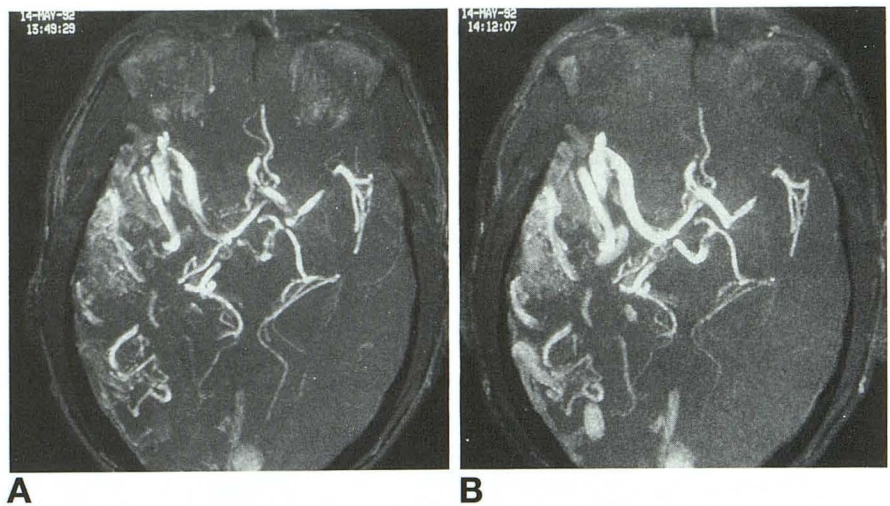

the carotid siphons. The same might be expected in areas of stenosis. The lack of general improvement and even degradation of image quality in adults, despite some mild signal improvement at areas of expected phase-related signal loss, is caused by the decreased contrast-to-noise ratios (Fig 7). Two reasons can account for the degradation of image quality when the shorter-echo sequence was used. First, the shorter-echo sequence has a larger bandwidth (195 Hz per pixel) than the longer-echo sequence (130 Hz per pixel) (Fig 7). Therefore, the signal-to-noise ratio for the images acquired by the shorter-echo sequence is about 0.8 of the longer-echo sequence. The maximum intensity projection algorithm works better when a high signal-to-noise ratio is available. Therefore, the maximum intensity projection is part of the cause of the loss of lumen definition for smaller vessels in the shorter-echo sequence when it is applied to lower signal-to-noise ratio data. In

addition, the T2* dephasing that occurs in the longer-TE sequence results in lower background signal than the short-TE sequence, allowing a better contrast-to-noise ratio and improving lumen definition and small vessel detail. In children, the high flow rates, which improve inflow, and the short-TE/FE sequence which reduces the phase-related signal loss, more than compensate for the decreased signal-to-noise ratio. However, in adults or children with slower cerebral blood flow, the contrast-to-noise ratio may not be fully compensated, because there is increased background signal, resulting in decreased lumen definition and peripheral vessel signal. Although it affects image quality, using magnetization transfer contrast, differing matrix size, and fat saturation does not affect the relative decrease in contrast-to-noise ratio for this technique comparison.

The "short-TE" sequence discussed in this study has been described as a short-TE/

Fig 7. A, In this adult, there are higher signal-to-noise and contrast-to-noise ratios in the long-TE/long-FE sequence.

B, There is loss of lumen definition and peripheral vessel detail using the shorter-echo sequence.

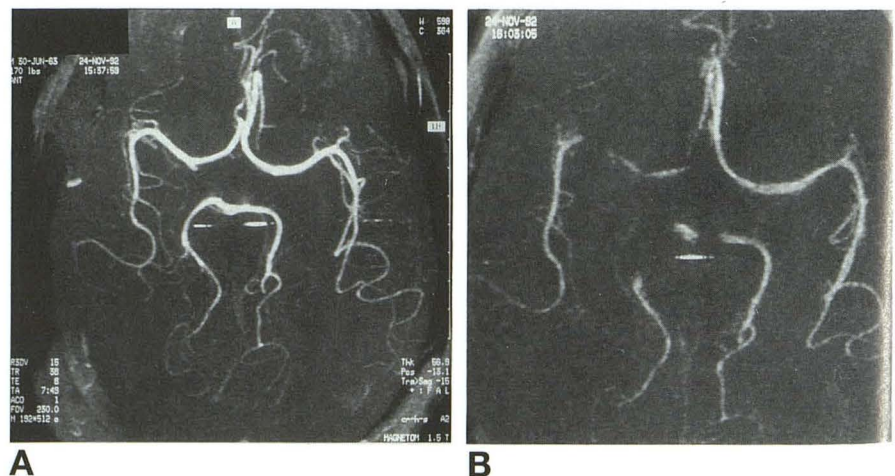

short-FE method. It is important to note that it is the gradient timings that determine the dephasing, not TE. The shorter-FE technique means the gradient will be on for a shorter time, thereby allowing less intravoxel dephasing. For example, an uncompensated sequence has a phase dispersion proportional to FE^2 for velocity and FE^3 for acceleration. For a velocity compensation sequence, the phase caused by acceleration varies as FE^2 . If a symmetric echo with 128 points before the echo requires an FE of 8 milliseconds, and an asymmetric echo with 64 points requires only 6.5 milliseconds, then the phase spread from acceleration is reduced by a factor of 1.5; whereas for 32 points, it requires only 4.2 milliseconds, and the phase spread is reduced by a factor of 3.6. This can change the phase-spread areas across a voxel from roughly 4π to π , for example, and a tremendous recovery of signal occurs. TE can have an effect if local field inhomogeneities are present. The latter will cause the sequence to become effectively uncompensated and destroy the phase coherence for both stationary and flowing spins. Asymmetric FE acquisition suffers from some blurring and for a fixed number of points will always appear to have less resolution and lower contrast-to-noise ratio than a more symmetric version. By going to 512 points, components of small vessels can become visible if their contrast-to-background tissue is sufficiently large. The blurring can be overcome by using partial Fourier reconstruction (14).

It is becoming apparent that no one MR angiographic sequence is ideal for all situations. Each case has to be assessed in an algorithmic approach appropriate to the imaging techniques available to each facility and using factors such as probable outcome (ie, if slow flow is expected). In addition, the algorithm may be altered by the impact of factors that may, in general, be implicit with the patient's age (ie, cardiac output and cerebral blood flow). Other influences such as arrhythmias or respiratory status may need to be explored for their impact on the algorithm. After such an assessment, the MR angiographic sequence must be chosen with the knowledge that it is a screening technique that may need to be altered for further information. For children, who grossly have normal age-related cerebral blood flow, we recommend using the short-echo sequence to reduce signal loss in major intracranial vessels. It

also must be noted that the use of the short-echo rather than the long-echo sequence is a double-edged sword. The signal dephasing in the longer-echo sequence, although known to overestimate areas of stenosis or mask normal flow, also helps point to areas of abnormality (see Fig 5). Use of the short-echo sequence requires interpretation criteria closer to those used for catheter angiography rather than extrapolations based on the degree of distal signal recovery. In this study we did not examine enough infants to know the best initial MR angiographic sequence for that group. The intracranial velocity and cerebral blood flow in infants is very sensitive to gestational age and neurologic and respiratory status, as well as the presence or absence of hydrocephalus (16, 17). It is possible that the low intracranial velocities and cerebral blood flow rates in infants, resulting in poor distal signal, will override any benefit of recovery of phase-related signal loss from the short echo. Although the short-echo sequence shows no advantage and some disadvantage as an initial MR angiographic screening technique for intracranial studies in adults, this sequence is beneficial in better defining disease in areas of suspected stenosis as a "second-look" technique.

In summary, we have found that a short-echo 3-D time-of-flight MR angiographic sequence with a shorter gradient-echo structure of TE of 5.1 and FE of 1.4 milliseconds made a significant improvement in intracranial MR angiography in children over a longer-echo, TE of 8.0 and FE of 6.4 milliseconds, sequence and over adults. We suggest this sequence, ideally with magnetization transfer contrast, as the best initial MR angiographic sequence for intracranial vasculature in the pediatric population outside infancy.

References

1. Nishimura DG, Macovski A, Pauly JM. Magnetic resonance angiography. *IEEE Trans Med Imag MI* 1986;5:140-151
2. Haacke EM, Lenz GW. Improving MR image quality in the presence of motion by using dephasing gradients. *AJR Am J Roentgenol* 1987;148:1251-1258
3. Axel L, Mortion D. MR flow imaging of velocity compensated/uncompensated difference images. *J Comput Assist Tomogr* 1987;11:31-34
4. Nayler GL, Firmin DN, Longmore DB. Blood flow imaging by cine magnetic resonance. *J Comput Assist Tomogr* 1986;10:715-722
5. Tkach JA, Ruggieri PM, Dillinger JJ, et al. Three-dimensional time-of-flight MR angiography with a specialized gradient head coil. *J Magn Reson Imaging* 1990;3:365-376

6. Haacke EM, Masaryk TJ, Wielopolski PA, et al. Optimizing blood vessel contrast in fast 3D imaging. *Magn Reson Med* 1990;14:202-221
7. Schmalbrock P, Yuan C, Chakeres W, Kohli J, Pelc NJ. Volume MR angiography: methods to achieve very short echo times. *Radiology* 1990;175:861-865
8. Haacke EM, Lindskog ED, Lin W. A fast iterative, partial Fourier technique capable of local phase recovery. *J Magn Reson* 1991;92:126-145
9. Kilner PJ, Firmin DN, Ress RSO, et al. Valve and great vessel stenosis: assessment with MR jet velocity mapping. *Radiology* 1991;178:229-235
10. Urchuk SN, Plewes DB. Mechanisms of flow-induced signal loss in MR angiography. *J Magn Reson Imaging* 1992;2:453-462
11. Lin W, Tkach JA, Haacke EM, Masaryk TJ. Enhanced contrast high resolution intracranial angiography: an application of MTC and fat saturation to short gradient echo compensation sequences. *Radiology* 1993;186:753-761
12. E. M. Haacke, W. Lin. Flow phenomena in magnetic resonance imaging, basic concepts and technique developments. *Neuroimaging Clin North Am* 1992;2:623-637
13. Duerk JL, Wendt RE. Motion artifacts and motion compensation. In: Potchen EJ, Haacke EM, Siebert JE, Gottshalk A, eds. *Magnetic Resonance Angiography*. St. Louis: Mosby, 1993:80-137
14. Heiserman TE, Drayer BP, Keller PJ, Fram EK. Intracranial vascular stenosis and occlusion: evaluation with three-dimensional time-of-flight MR angiography. *Radiology* 1992;185:667-673
15. Bode H, Wais U. Age dependence of flow velocities in basal cerebral arteries. *Arch Dis Child* 1988;63:606-611
16. Adams RJ, Nichols AT, Hess DC. Normal values and physiological variables. In: Newell DW, Aaslid R, eds. *Transcranial Doppler*. New York: Raven Press, 1992:41-48
17. Kirsch JR, Traystman RJ, Rodgers MC. Cerebral blood flow measurement techniques in infants and children. *Pediatrics* 1985;75:887-895